

P1707A

Notebook LCD Panel EMI Reduction IC

Description

The P1707A is a versatile spread spectrum frequency modulator designed specifically for input clock frequencies. The P1707A reduces electromagnetic interference (EMI) at the clock source, allowing system wide reduction of EMI of down stream clock and data dependent signals. The P1707A allows significant system cost savings by reducing the number of circuit board layers, ferrite beads, shielding, and other passive components that are traditionally required to pass EMI regulations.

The P1707A modulates the output of a single PLL in order to “spread” the bandwidth of a synthesized clock, and more importantly, decreases the peak amplitudes of its harmonics. This results in significantly lower system EMI compared to the typical narrow band signal produced by oscillators and most frequency generators. Lowering EMI by increasing a signal’s bandwidth is called ‘spread spectrum clock generation.’

The P1707A uses the most efficient and optimized modulation profile approved by the FCC and is implemented in a proprietary all digital method.

Applications

The P1707A is targeted towards notebook LCD displays, and other displays using an LVDS interface, PC peripheral devices, and embedded systems.

Features

- FCC Approved Method of EMI Attenuation
- Generates a Low EMI Spread Spectrum Clock of the Input Frequency
- Optimized for Frequency Range from 40 MHz to 175 MHz
- Internal Loop Filter Minimizes External Components and Board Space
- Four Selectable Spread Ranges
- Low Inherent Cycle-to-Cycle Jitter
- 3.3 V Operating Voltage
- Ultra-low Power CMOS Design
 - 14.85 mA @ 3.3 V, 140 MHz
 - 16.69 mA @ 3.3 V, 162 MHz
 - 17.78 mA @ 3.3 V, 175 MHz
- Supports Notebook VGA and Other LCD Timing Controller Applications
- Pinout Compatible to ICS MK1707 and Cypress CY25561 / CY25560
- SSON / SBM Pin for Spread Spectrum On/Off and Standby Mode Controls
- Available in 8-pin SOIC and TSSOP Packages
- These are Pb-Free Devices



ON Semiconductor®

<http://onsemi.com>



SOIC-8
S SUFFIX
CASE 751BD



TSSOP-8
T SUFFIX
CASE 948AL

PIN CONFIGURATION

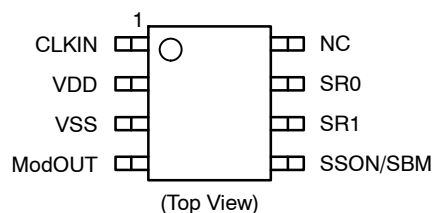

ORDERING INFORMATION

See detailed ordering and shipping information in the package dimensions section on page 6 of this data sheet.

P1707A

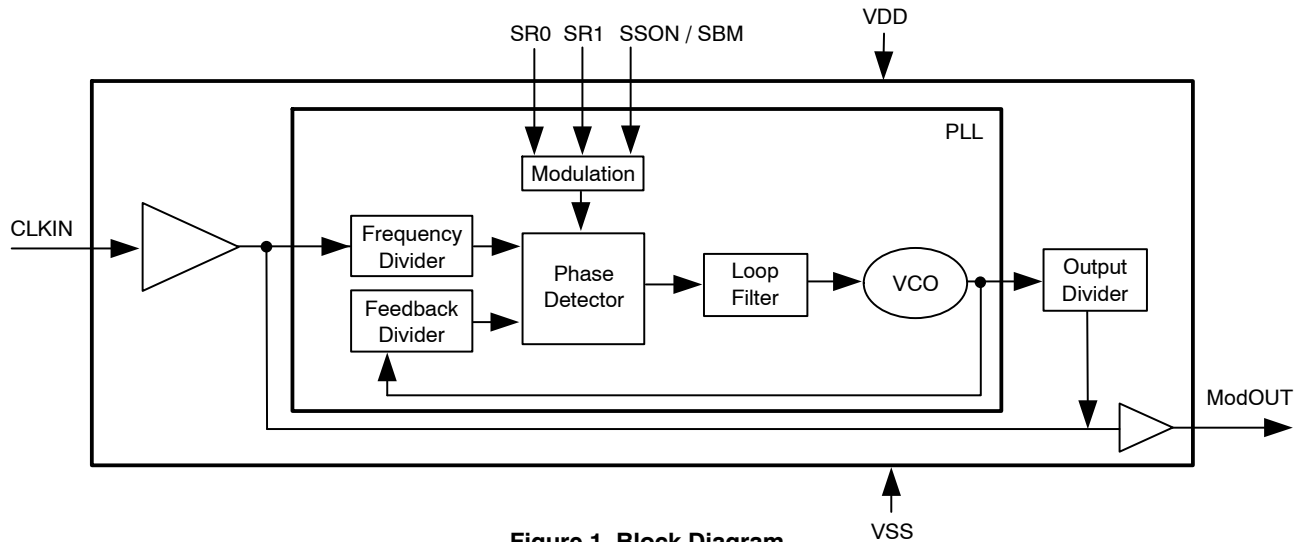

Figure 1. Block Diagram

Table 1. PIN DESCRIPTION

Pin#	Pin Name	Type	Description
1	CLKIN	I	Connect to externally generated clock signal. To put the part into standby mode, disable the input clock signal to this pin and pull SSON/SBM (pin 5) low. Refer to <i>Standby Mode Selection</i> Table.
2	VDD	P	Connect to +3.3 V. (Place a decoupling 0.1 μ F close to pin and ground.)
3	VSS	P	Ground Connection. Connect to system ground.
4	ModOUT	O	Spread spectrum clock output.
5	SSON / SBM	I	Spread Spectrum On/Off and standby mode control. Refer to <i>Standby Mode Selection</i> Table. This pin has an internal pull-up resistor.
6	SR1	I	Digital logic input used to select Spreading Range. Refer to <i>Spread Spectrum Selection</i> Table. This pin has an internal pull-up resistor.
7	SR0	I	Digital logic input used to select Spreading Range. Refer to <i>Spread Spectrum Selection</i> Table. This pin has an internal pull-up resistor.
8	NC	-	No connect.

Table 2. STANDBY MODE SELECTION

CLKIN	SSON / SBM	Spread Spectrum	ModOUT	PLL	Mode
Disabled	0	N/A	Disabled	Disabled	Standby
Disabled	1	N/A	Disabled	Free Running	Free Running
Enabled	0	Off	Reference	Disabled	Buffer out
Enabled	1	On	Normal	Normal	Normal

Table 3. SPREAD RANGE SELECTION

SR1	SR0	Spreading Range	Modulation Rate
0	0	$\pm 1.50\%$	$(F_{IN}/80) * 34.72$ KHz
0	1	$\pm 2.50\%$	$(F_{IN}/80) * 34.72$ KHz
1	0	$\pm 0.50\%$	$(F_{IN}/80) * 34.72$ KHz
1	1	$\pm 1.00\%$	$(F_{IN}/80) * 34.72$ KHz

P1707A

Table 4. ABSOLUTE MAXIMUM RATINGS

Symbol	Parameter	Rating	Unit
VDD, VIN	Voltage on any pin with respect to Ground	-0.5 to +4.6	V
T _{STG}	Storage temperature	-65 to +125	°C
T _A	Operating temperature	-40 to +85	°C
T _s	Max. Soldering Temperature (10 sec)	260	°C
T _J	Junction Temperature	150	°C
T _{DV}	Static Discharge Voltage (As per JEDEC STD22- A114-B)	2	KV

Stresses exceeding Maximum Ratings may damage the device. Maximum Ratings are stress ratings only. Functional operation above the Recommended Operating Conditions is not implied. Extended exposure to stresses above the Recommended Operating Conditions may affect device reliability.

Table 5. DC ELECTRICAL CHARACTERISTICS

Symbol	Parameter	Min	Typ	Max	Unit
V _{IL}	Input low voltage	VSS-0.3		0.8	V
V _{IH}	Input high voltage	2.0		VDD+0.3	V
I _{IL}	Input low current (pull-up resistors on inputs SR0, SR1 and SSON / SBM)			-35	μA
I _{IH}	Input high current			35	μA
I _{XOL}	X _{OUT} output low current (V _{XOL} @ 0.4 V, VDD = 3.3 V)		3		mA
I _{XOH}	X _{OUT} output high current (V _{XOH} @ 2.5 V, VDD = 3.3 V)		3		mA
V _{OL}	Output low voltage VDD = 3.3 V, I _{OL} = 20 mA			0.4	V
V _{OH}	Output high voltage VDD = 3.3 V, I _{OH} = 20 mA	2.5			V
I _{CC}	Dynamic supply current normal mode 3.3 V and 10 pF loading	8.46	12	17.78	mA
I _{DD}	Static supply current standby mode		0.6		mA
VDD	Operating voltage	2.7	3.3	3.7	V
t _{ON}	Power up time (first locked clock cycle after power up)		0.18		mS
Z _{OUT}	Clock output impedance		20		Ω

Table 6. AC ELECTRICAL CHARACTERISTICS

Symbol	Parameter	Min	Typ	Max	Unit
f _{IN}	Input frequency	40		175	MHz
f _{OUT}	Output frequency	40		175	MHz
t _{LH} (Note 1)	Output rise time (Measured from 0.8 V to 2.0 V)	0.7	0.9	1.1	nS
t _{HL} (Note 1)	Output fall time (Measured from 2.0 V to 0.8 V)	0.6	0.8	1.0	nS
t _{JC}	Jitter (Cycle-to-cycle)	-	-	360	pS
t _D	Output duty cycle	45	50	55	%

1. t_{LH} and t_{HL} are measured into a capacitive load of 15 pF.

P1707A

PACKAGE DIMENSIONS

TSSOP8, 4.4x3
CASE 948AL-01
ISSUE O

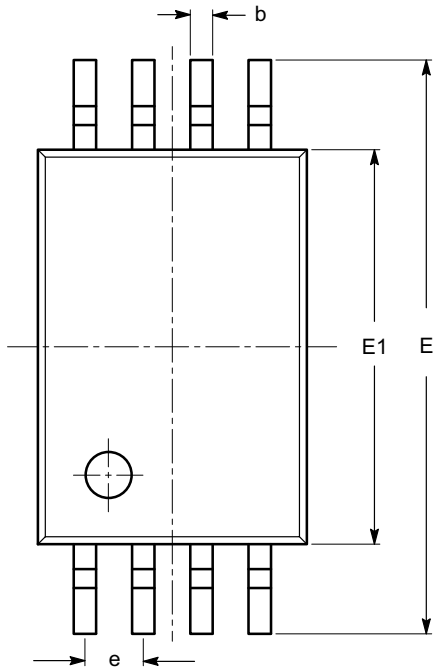

SYMBOL	MIN	NOM	MAX
A			1.20
A1	0.05		0.15
A2	0.80	0.90	1.05
b	0.19		0.30
c	0.09		0.20
D	2.90	3.00	3.10
E	6.30	6.40	6.50
E1	4.30	4.40	4.50
e	0.65 BSC		
L	1.00 REF		
L1	0.50	0.60	0.75
θ	0°		8°

TOP VIEW

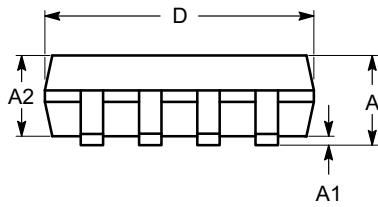

SIDE VIEW

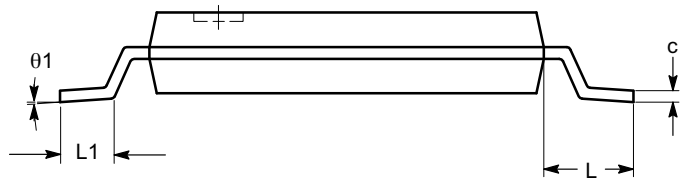

END VIEW

Notes:

- (1) All dimensions are in millimeters. Angles in degrees.
- (2) Complies with JEDEC MO-153.

P1707A

PACKAGE DIMENSIONS

SOIC 8, 150 mils
CASE 751BD-01
ISSUE O

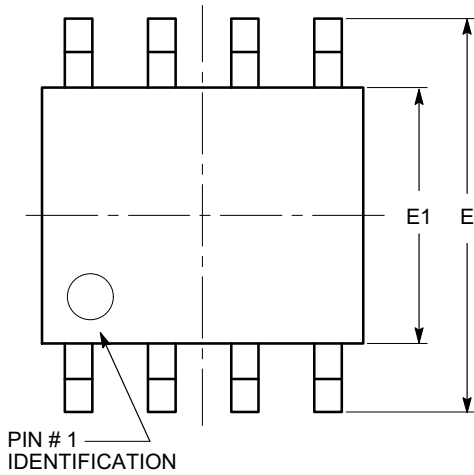

TOP VIEW

SYMBOL	MIN	NOM	MAX
A	1.35		1.75
A1	0.10		0.25
b	0.33		0.51
c	0.19		0.25
D	4.80		5.00
E	5.80		6.20
E1	3.80		4.00
e	1.27 BSC		
h	0.25		0.50
L	0.40		1.27
θ	0°		8°

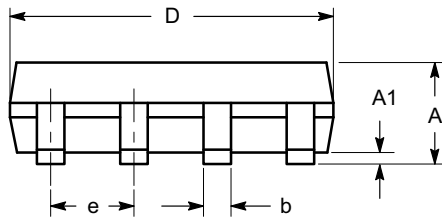

SIDE VIEW

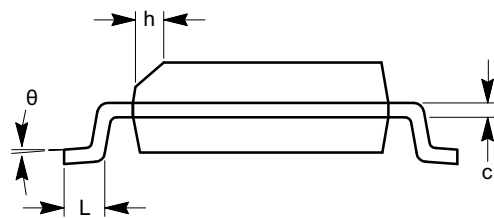

END VIEW

Notes:

- (1) All dimensions are in millimeters. Angles in degrees.
- (2) Complies with JEDEC MS-012.

P1707A

Table 7. ORDERING INFORMATION

Part Number	Marking	Package Type	Qty per Reel	Temperature
P1707AF-08ST	P1707AF	8-pin SOIC, Tube, Pb-Free		Commercial
P1707AF-08SR	P1707AF	8-pin SOIC, Tape & Reel, Pb-Free	2500	Commercial
P1707AF-08TT	P1707AF	8-pin TSSOP, Tube, Pb-Free		Commercial
P1707AF-08TR	P1707AF	8-pin TSSOP, Tape and Reel, Pb-Free	2500	Commercial
P1707AG-08ST	P1707AG	8-pin SOIC, Tube, Green		Commercial
P1707AG-08SR	P1707AG	8-pin SOIC, Tape & Reel, Green	2500	Commercial
P1707AG-08TT	P1707AG	8-pin TSSOP, Tube, Green		Commercial
P1707AG-08TR	P1707AG	8-pin TSSOP, Tape and Reel, Green	2500	Commercial

ON Semiconductor and  are registered trademarks of Semiconductor Components Industries, LLC (SCILLC). SCILLC reserves the right to make changes without further notice to any products herein. SCILLC makes no warranty, representation or guarantee regarding the suitability of its products for any particular purpose, nor does SCILLC assume any liability arising out of the application or use of any product or circuit, and specifically disclaims any and all liability, including without limitation special, consequential or incidental damages. "Typical" parameters which may be provided in SCILLC data sheets and/or specifications can and do vary in different applications and actual performance may vary over time. All operating parameters, including "Typicals" must be validated for each customer application by customer's technical experts. SCILLC does not convey any license under its patent rights nor the rights of others. SCILLC products are not designed, intended, or authorized for use as components in systems intended for surgical implant into the body, or other applications intended to support or sustain life, or for any other application in which the failure of the SCILLC product could create a situation where personal injury or death may occur. Should Buyer purchase or use SCILLC products for any such unintended or unauthorized application, Buyer shall indemnify and hold SCILLC and its officers, employees, subsidiaries, affiliates, and distributors harmless against all claims, costs, damages, and expenses, and reasonable attorney fees arising out of, directly or indirectly, any claim of personal injury or death associated with such unintended or unauthorized use, even if such claim alleges that SCILLC was negligent regarding the design or manufacture of the part. SCILLC is an Equal Opportunity/Affirmative Action Employer. This literature is subject to all applicable copyright laws and is not for resale in any manner.

PUBLICATION ORDERING INFORMATION

LITERATURE FULFILLMENT:

Literature Distribution Center for ON Semiconductor
P.O. Box 5163, Denver, Colorado 80217 USA
Phone: 303-675-2175 or 800-344-3860 Toll Free USA/Canada
Fax: 303-675-2176 or 800-344-3867 Toll Free USA/Canada
Email: orderlit@onsemi.com

N. American Technical Support: 800-282-9855 Toll Free
USA/Canada
Europe, Middle East and Africa Technical Support:
Phone: 421 33 790 2910
Japan Customer Focus Center
Phone: 81-3-5773-3850

ON Semiconductor Website: www.onsemi.com

Order Literature: <http://www.onsemi.com/orderlit>

For additional information, please contact your local Sales Representative